



P-Channel JFETs

| | |
|------|--------|
| J174 | SST174 |
| J175 | SST175 |
| J176 | SST176 |
| J177 | SST177 |

| PRODUCT SUMMARY | | | | |
|-----------------|-------------------|-------------------------------|-----------------------|-------------------|
| Part Number | $V_{GS(off)}$ (V) | $r_{DS(on)}$ Max (Ω) | $I_{D(off)}$ Typ (pA) | t_{ON} Typ (ns) |
| J/SST174 | 5 to 10 | 85 | -10 | 25 |
| J/SST175 | 3 to 6 | 125 | -10 | 25 |
| J/SST176 | 1 to 4 | 250 | -10 | 25 |
| J/SST177 | 0.8 to 2.25 | 300 | -10 | 25 |

FEATURES

- Low On-Resistance: J174 <85 Ω
- Fast Switching— t_{ON} : 25 ns
- Low Leakage: -10 pA
- Low Capacitance: 5 pF
- Low Insertion Loss

BENEFITS

- Low Error Voltage
- High-Speed Analog Circuit Performance
- Negligible “Off-Error,” Excellent Accuracy
- Good Frequency Response
- Eliminates Additional Buffering

APPLICATIONS

- Analog Switches
- Choppers
- Sample-and-Hold
- Normally “On” Switches
- Current Limiters

DESCRIPTION

The J/SST174 series consists of p-channel analog switches designed to provide low on-resistance and fast switching. This series simplifies series-shunt switching applications when combined with the Siliconix J/SST111 series.

The TO-226AA (TO-92) plastic package provides a low-cost option, while the TO-236 (SOT-23) package provides surface-mount capability. Both the J and SST series are available in tape-and-reel for automated assembly (see Packaging Information).

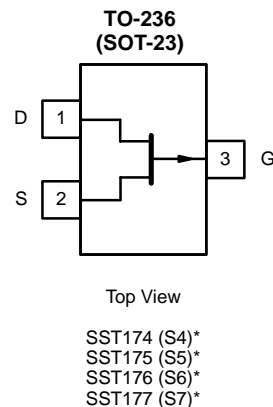
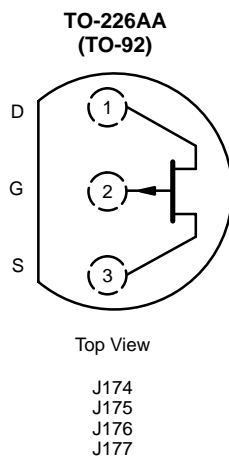

*Marking Code for TO-236

For applications information see AN104.



ABSOLUTE MAXIMUM RATINGS

Gate-Drain Voltage 30 V
 Gate-Source Voltage 30 V
 Gate Current -50 mA
 Storage Temperature -55 to 150°C
 Operating Junction Temperature -55 to 150°C

Lead Temperature (1/16" from case for 10 sec.) 300°C
 Power Dissipation^a 350 mW

Notes
 a. Derate 2.8 mW/°C above 25°C

| SPECIFICATIONS FOR J/SST174 AND J/SST175 (T _A = 25°C UNLESS OTHERWISE NOTED) | | | | | | | | |
|-----------------------------------------------------------------------------------------|----------------------|------------------------------------------------------------------------------|------------------|----------|------|----------|-----|------------|
| Parameter | Symbol | Test Conditions | Typ ^a | Limits | | | | Unit |
| | | | | J/SST174 | | J/SST175 | | |
| | | | | Min | Max | Min | Max | |
| Static | | | | | | | | |
| Gate-Source Breakdown Voltage | V _{(BR)GSS} | I _G = 1 μA, V _{DS} = 0 V | 45 | 30 | | 30 | | V |
| Gate-Source Cutoff Voltage | V _{GS(off)} | V _{DS} = -15 V, I _D = -10 nA | | 5 | 10 | 3 | 6 | |
| Saturation Drain Current ^b | I _{DSS} | V _{DS} = -15 V, V _{GS} = 0 V | | -20 | -135 | -7 | -70 | mA |
| Gate Reverse Current | I _{GSS} | V _{GS} = 20 V, V _{DS} = 0 V T _A = 125°C | 0.01 5 | | 1 | | 1 | nA |
| Gate Operating Current | I _G | V _{DG} = -15 V, I _D = -1 mA | 0.01 | | | | | |
| Drain Cutoff Current | I _{D(off)} | V _{DS} = -15 V, V _{GS} = 10 V T _A = 125°C | -0.01 -5 | | -1 | | -1 | |
| Drain-Source On-Resistance | r _{DS(on)} | V _{GS} = 0 V, V _{DS} = -0.1 V | | | 85 | | 125 | Ω |
| Gate-Source Forward Voltage | V _{GS(F)} | I _G = -1 mA, V _{DS} = 0 V | -0.7 | | | | | V |
| Dynamic | | | | | | | | |
| Common-Source Forward Transconductance | g _{fs} | V _{DS} = -15 V, I _D = -1 mA f = 1 kHz | 4.5 | | | | | mS |
| Common-Source Output Conductance | g _{os} | | 20 | | | | | μS |
| Drain-Source On-Resistance | r _{ds(on)} | V _{GS} = 0 V, I _D = 0 mA, f = 1 kHz | | | 85 | | 125 | Ω |
| Common-Source Input Capacitance | C _{iss} | V _{DS} = 0 V, V _{GS} = 0 V, f = 1 MHz | 20 | | | | | pF |
| Common-Source Reverse Transfer Capacitance | C _{rss} | V _{DS} = 0 V, V _{GS} = 10 V f = 1 MHz | 5 | | | | | |
| Equivalent Input Noise Voltage | e _n | V _{DG} = -10 V, I _D = -1 mA f = 1 kHz | 20 | | | | | nV/ √Hz |
| Switching | | | | | | | | |
| Turn-On Time | t _{d(on)} | V _{GS(L)} = 0 V, V _{GS(H)} = 10 V See Switching Circuit | 10 | | | | | ns |
| | t _r | | 15 | | | | | |
| Turn-Off Time | t _{d(off)} | | 10 | | | | | |
| | t _f | | 20 | | | | | |

Notes
 a. Typical values are for DESIGN AID ONLY, not guaranteed nor subject to production testing.
 b. Pulse test: PW ≤ 300 μs duty cycle ≤ 3%.

PSCIA



| SPECIFICATIONS FOR J/SST176 AND J/SST177 (T _A = 25 °C UNLESS OTHERWISE NOTED) | | | | | | | | |
|------------------------------------------------------------------------------------------|----------------------|------------------------------------------------------------------------------|------------------|----------|-----|----------|------|------------|
| Parameter | Symbol | Test Conditions | Typ ^a | Limits | | | | Unit |
| | | | | J/SST176 | | J/SST177 | | |
| | | | | Min | Max | Min | Max | |
| Static | | | | | | | | |
| Gate-Source Breakdown Voltage | V _{(BR)GSS} | I _G = 1 μA, V _{DS} = 0 V | 45 | 30 | | 30 | | V |
| Gate-Source Cutoff Voltage | V _{GS(off)} | V _{DS} = -15 V, I _D = -10 nA | | 1 | 4 | 0.8 | 2.25 | |
| Saturation Drain Current ^b | I _{DSS} | V _{DS} = -15 V, V _{GS} = 0 V | | -2 | -35 | -1.5 | -20 | mA |
| Gate Reverse Current | I _{GSS} | V _{GS} = 20 V, V _{DS} = 0 V | 0.01 | | 1 | | 1 | nA |
| | | T _A = 125 °C | 5 | | | | | |
| Gate Operating Current | I _G | V _{DG} = -15 V, I _D = -1 mA | 0.01 | | | | | nA |
| Drain Cutoff Current | I _{D(off)} | V _{DS} = -15 V, V _{GS} = 10 V | -0.01 | | -1 | | -1 | |
| | | T _A = 125 °C | -5 | | | | | |
| Drain-Source On-Resistance | r _{DS(on)} | V _{GS} = 0 V, V _{DS} = -0.1 V | | | 250 | | 300 | Ω |
| Gate-Source Forward Voltage | V _{GS(F)} | I _G = -1 mA, V _{DS} = 0 V | -0.7 | | | | | V |
| Dynamic | | | | | | | | |
| Common-Source Forward Transconductance | g _{fs} | V _{DS} = -15 V, I _D = -1 mA f = 1 kHz | 4.5 | | | | | mS |
| Common-Source Output Conductance | g _{os} | | 20 | | | | | μS |
| Drain-Source On-Resistance | r _{ds(on)} | V _{GS} = 0 V, I _D = 0 mA, f = 1 kHz | | | 250 | | 300 | Ω |
| Common-Source Input Capacitance | C _{iss} | V _{DS} = 0 V, V _{GS} = 0 V, f = 1 MHz | 20 | | | | | pF |
| Common-Source Reverse Transfer Capacitance | C _{rss} | V _{DS} = 0 V, V _{GS} = 10 V f = 1 MHz | 5 | | | | | |
| Equivalent Input Noise Voltage | e _n | V _{DG} = -10 V, I _D = -1 mA f = 1 kHz | 20 | | | | | nV/ √Hz |
| Switching | | | | | | | | |
| Turn-On Time | t _{d(on)} | V _{GS(L)} = 0 V, V _{GS(H)} = 10 V See Switching Circuit | 10 | | | | | ns |
| | t _r | | 15 | | | | | |
| Turn-Off Time | t _{d(off)} | | 10 | | | | | |
| | t _f | | 20 | | | | | |

Notes

- a. Typical values are for DESIGN AID ONLY, not guaranteed nor subject to production testing.
- b. Pulse test: PW ≤ 300 μs duty cycle ≤ 3%.

PSCIA

TYPICAL CHARACTERISTICS ($T_A = 25^\circ\text{C}$ UNLESS OTHERWISE NOTED)

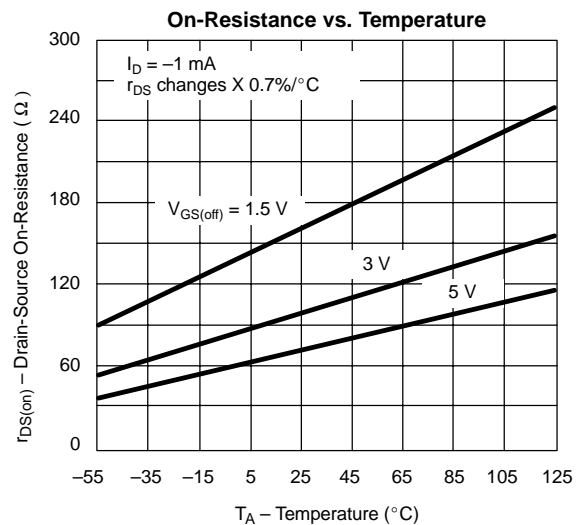
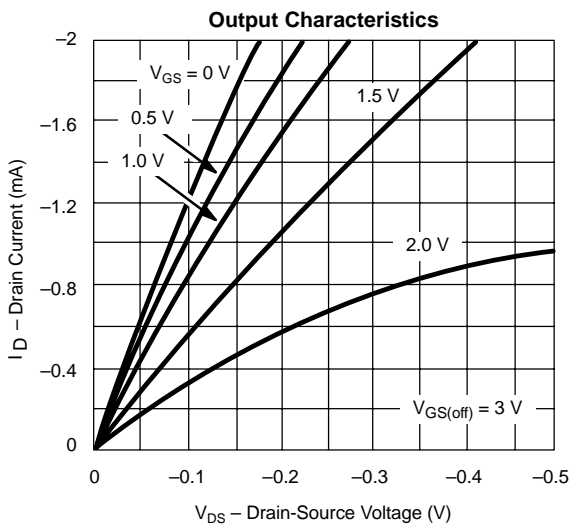
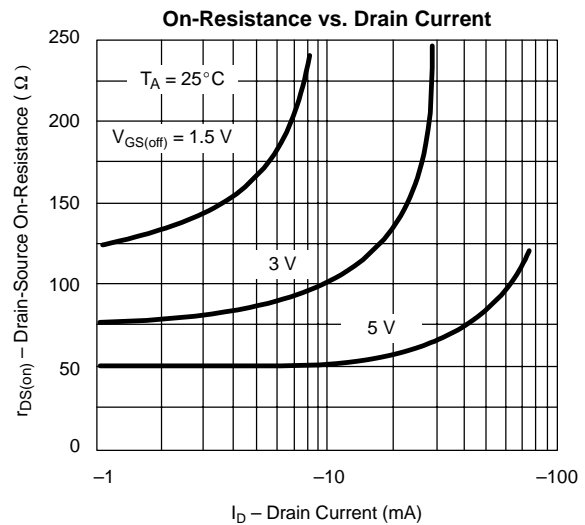
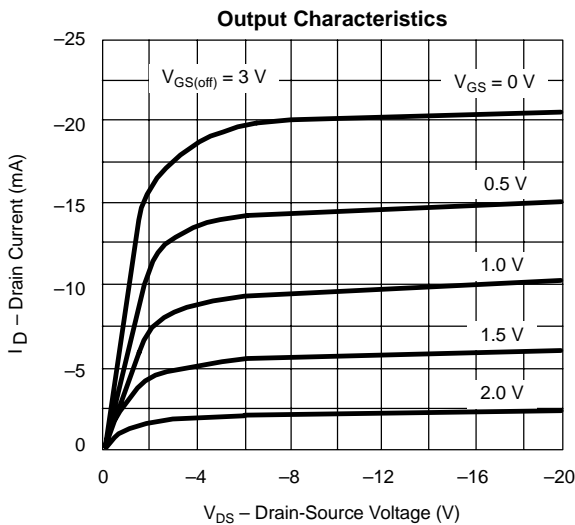
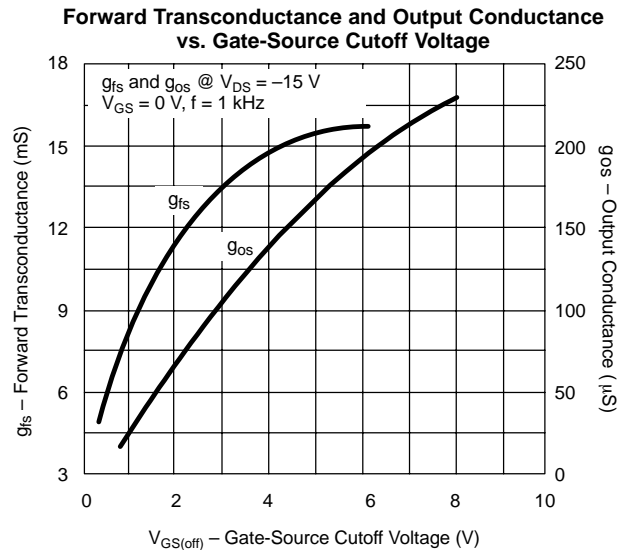
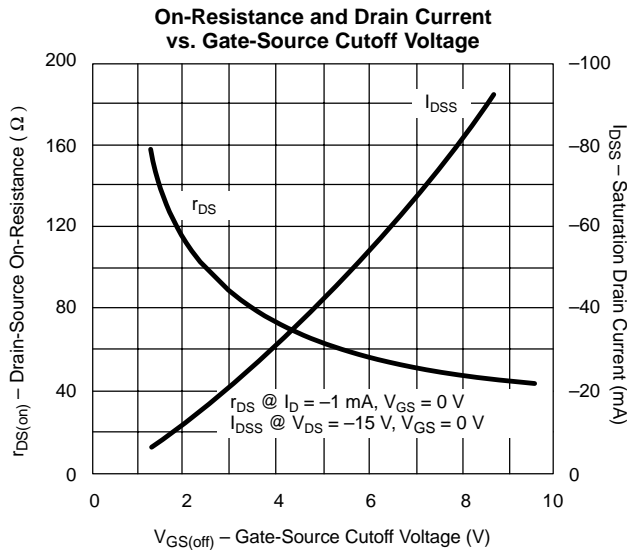



TYPICAL CHARACTERISTICS ($T_A = 25^\circ\text{C}$ UNLESS OTHERWISE NOTED)

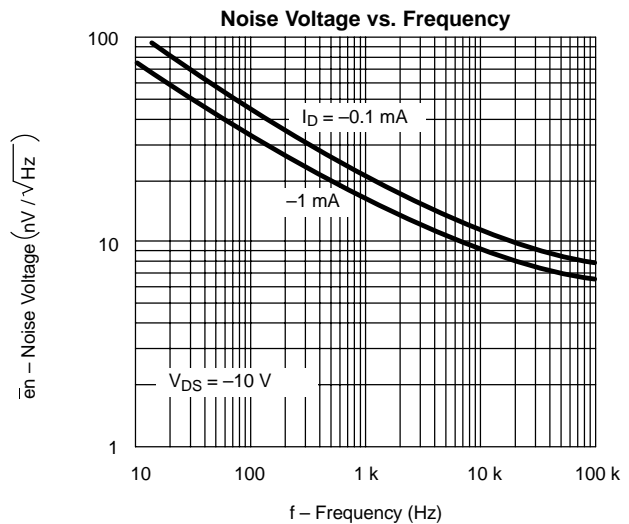
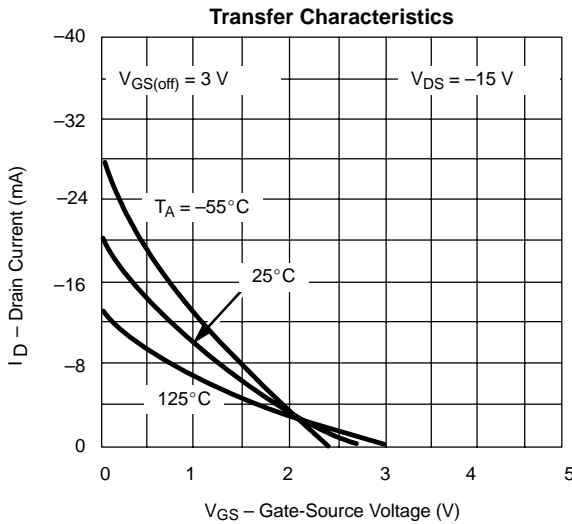
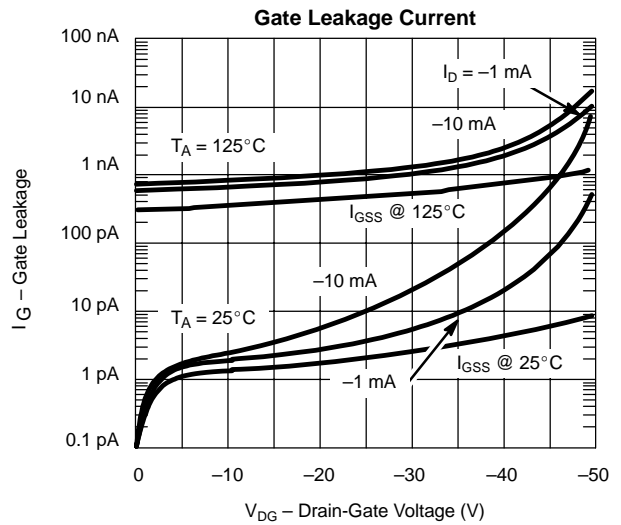
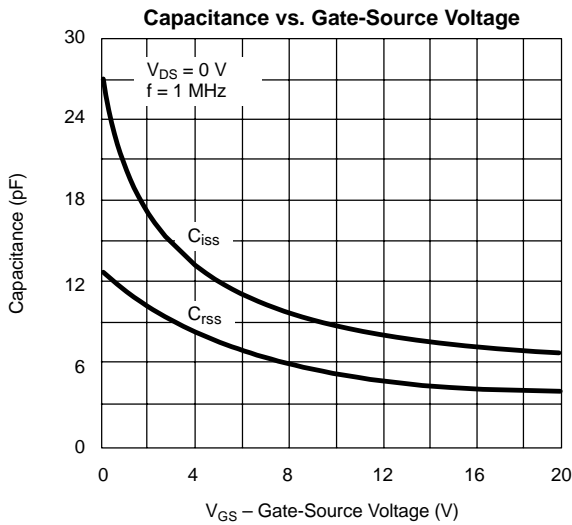
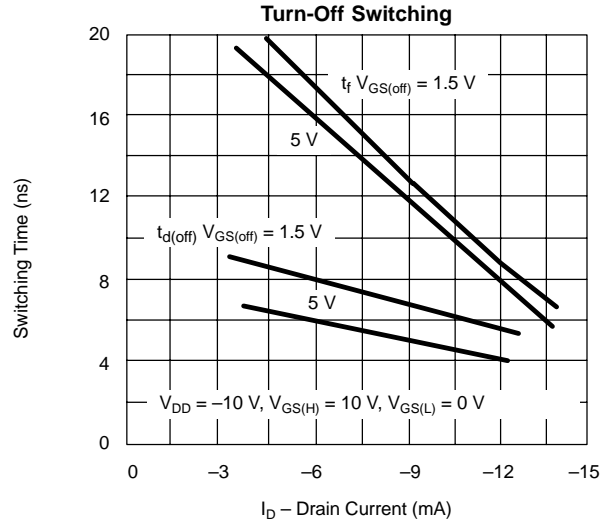
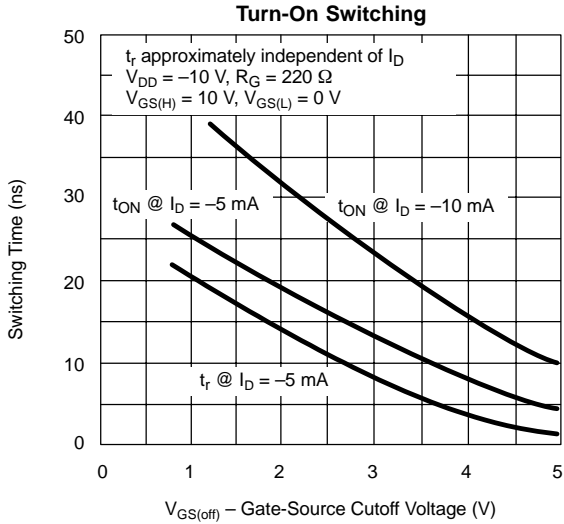

| SWITCHING TIME TEST CIRCUIT | | | | |
|-----------------------------|--------------|--------------|---------------|---------------|
| | 174 | 175 | 176 | 177 |
| V_{DD} | -10 V | -6 V | -6 V | -6 V |
| V_{GG} | 20 V | 12 V | 8 V | 5 V |
| R_L^* | 560 Ω | 750 Ω | 1800 Ω | 5600 Ω |
| R_G^* | 100 Ω | 220 Ω | 390 Ω | 390 Ω |
| $I_{D(on)}$ | -15 mA | -7 mA | -3 mA | -1 mA |

*Non-inductive

INPUT PULSE

Rise Time < 1 ns
 Fall Time < 1 ns
 Pulse Width 100 ns
 PRF 1 MHz

SAMPLING SCOPE

Rise Time 0.4 ns
 Input Resistance 10 M Ω
 Input Capacitance 1.5 pF

See Typical Characteristics curves for changes.

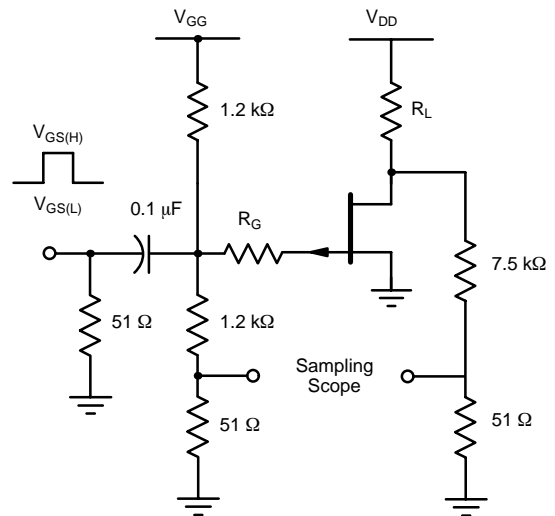



Notice

Specifications of the products displayed herein are subject to change without notice. Vishay Intertechnology, Inc., or anyone on its behalf, assumes no responsibility or liability for any errors or inaccuracies.

Information contained herein is intended to provide a product description only. No license, express or implied, by estoppel or otherwise, to any intellectual property rights is granted by this document. Except as provided in Vishay's terms and conditions of sale for such products, Vishay assumes no liability whatsoever, and disclaims any express or implied warranty, relating to sale and/or use of Vishay products including liability or warranties relating to fitness for a particular purpose, merchantability, or infringement of any patent, copyright, or other intellectual property right.

The products shown herein are not designed for use in medical, life-saving, or life-sustaining applications. Customers using or selling these products for use in such applications do so at their own risk and agree to fully indemnify Vishay for any damages resulting from such improper use or sale.